

# 562











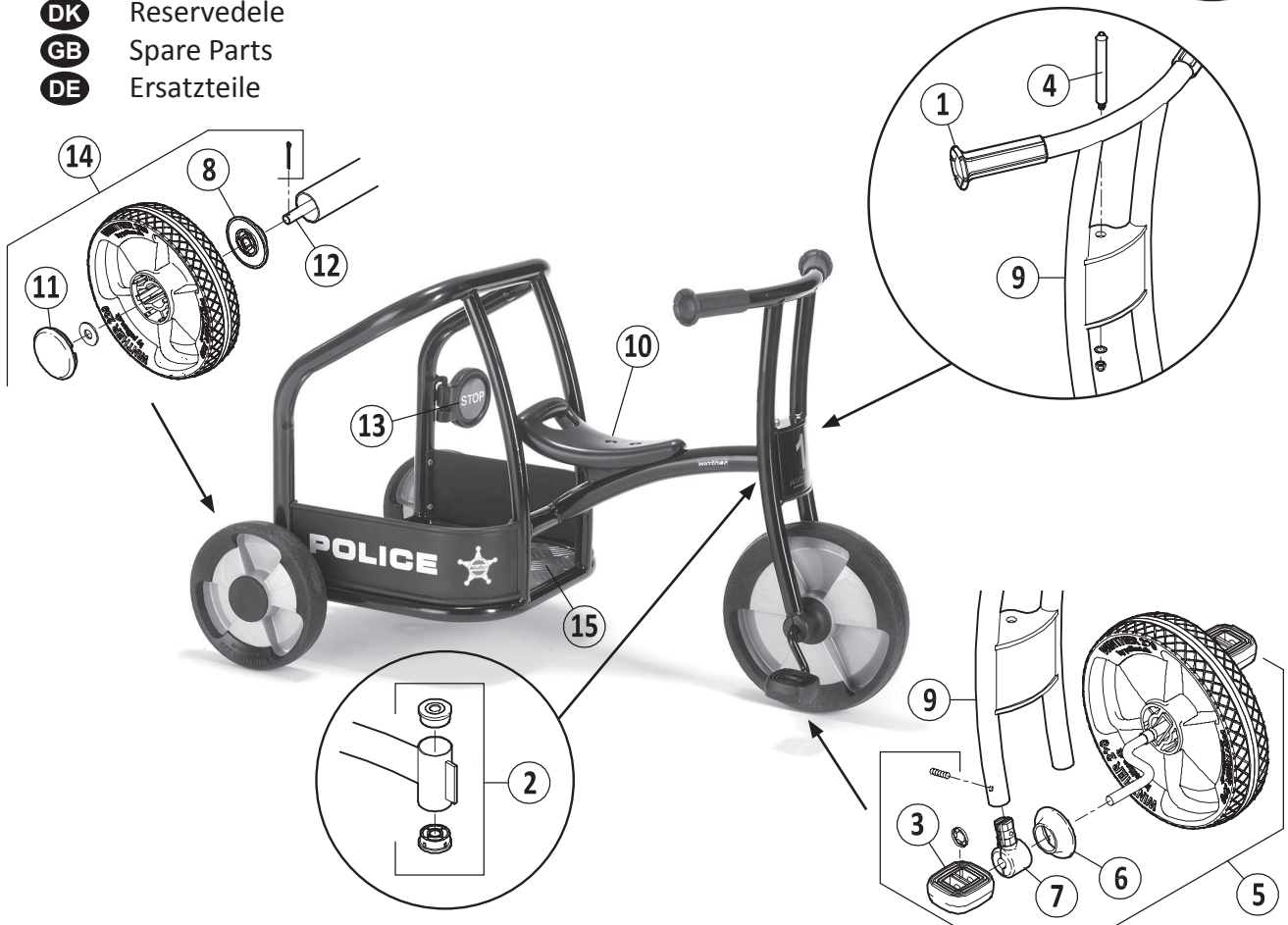























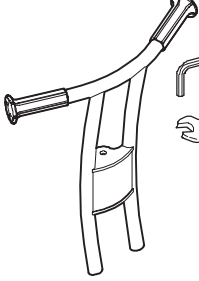
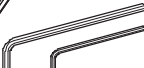
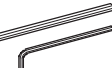



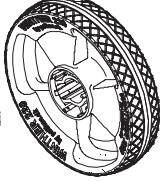

EN 71

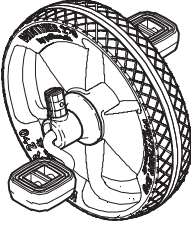
ASTM F963



- DK** Reservedele
- GB** Spare Parts
- DE** Ersatzteile

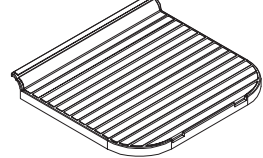

Pos.		Pos.		Pos.	
1	 x2	6	 x2	11	 x2
2	 x2	7	 x2  x2  x1	12	 x1  x2  x2
3	 x2  x2	8	 x2	13	 x1  x1  x1
4	 x1  x1  x1  x2  x1	9	     	14	    
5	   	10	  	15	 

# 562



EN 71

ASTM  
F963



- DK** Reservedele
- GB** Spare Parts
- DE** Ersatzteile

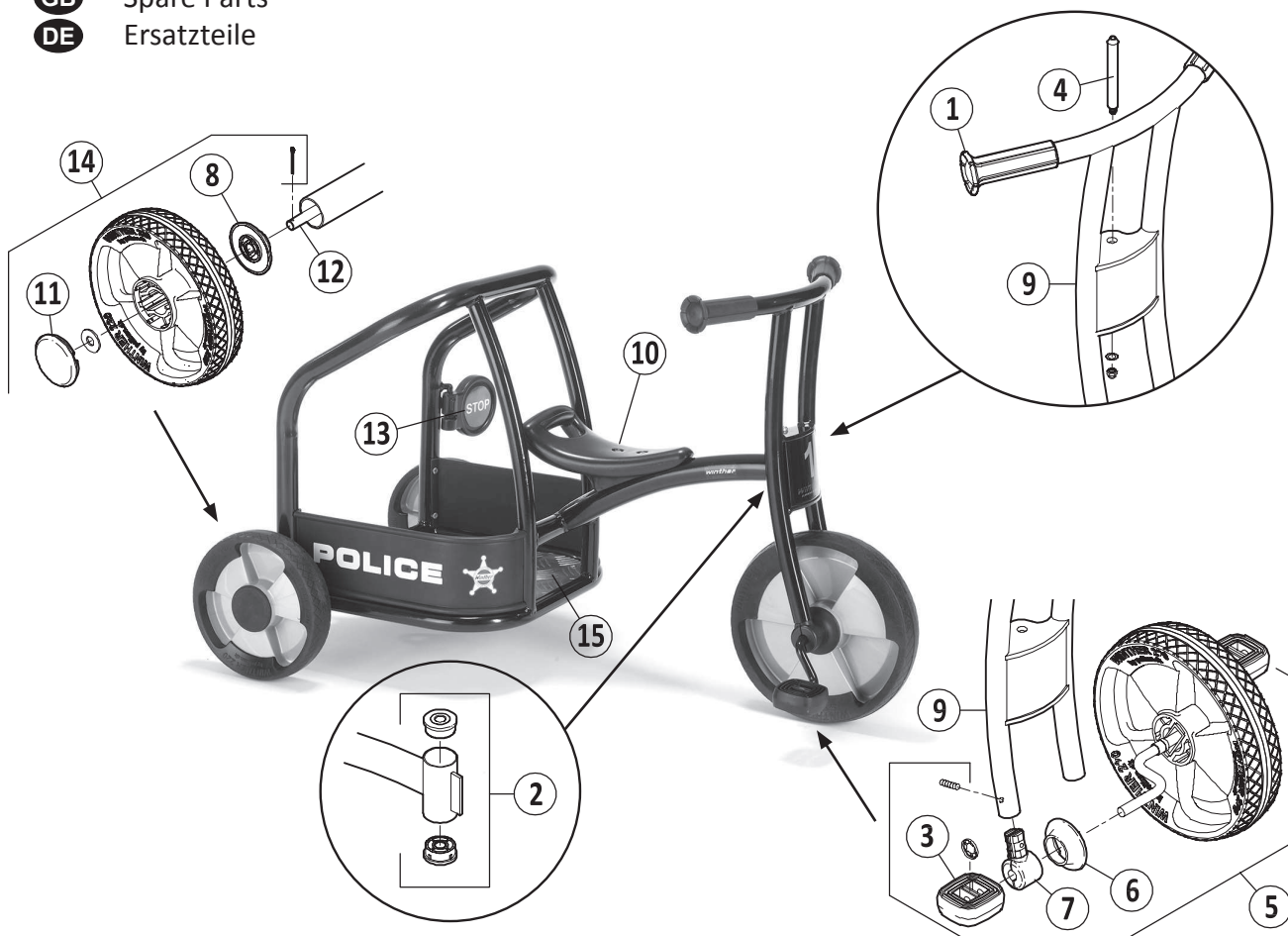

		562.00			
		Version			
Pos.	1.1	2.0			
1	50403	50403			
2	50404	50404			
3	50410	50410			
4	50401	50401			
5	50461	50461			
6	50405	50405			
7	50406	50406			
8	50419	50419			
9	50456	50456			
10	50480	50480			
11	50420	50420			
12	50413	50413			
13	50481	50481			
14	50471	50471			
15	50498	50498			
16	-	-			
17	-	-			
18	-	-			

